



User Manual

Contents

- 03** Welcome
- 05** Important Safeguards
- 06** Precautions for Safe Use
- 07** Cautions During Operation
- 08** Parts and Accessories
- 10** How to Disassemble: Chamber
- 11** How to Assemble: Chamber Set and Base
- 12** How to Assemble: Juice & Smoothie Strainer
- 14** How to Assemble: Sorbet Strainer
- 16** How to Prepare Ingredients for Optimal Juicing and Maximum Nutrient Extraction (Strainer Types)
- 17** How to Use: Overview
- 18** How to Use: Pulp Control Lever by Mode
- 19** When the Auger Stops During Operation
- 20** How to Clean
- 22** Before Requesting a Repair / Troubleshooting
- 24** Product Specifications / Warranty

Vitality 5800 (Household use only / Warranty Included)

- Read the instructions carefully before using.
- Keep these instructions somewhere easily accessible.
- Use only with 230-240V AC power supply.
- Design and product development may be upgraded without notice.
- Any quality improvements are subject to change without notice.



02





03

Welcome

Thank you for purchasing your new Nama Cold Press Juicer. We are very excited to welcome you to our Nama brand and community. One of our goals is to empower you to make healthy choices that taste good and are fun to make. This brand is built on the idea that our wellness rituals will help everyone on their path to becoming better, every day.

We want you to maximize the benefits from your new Nama Cold Press Juicer and be able to use it with the utmost confidence, so please read through this user manual prior to using.

At Nama, we aim to provide you and our community with tools to develop confidence in creating your own wellness journey to becoming better, every day. We strive to continually improve our products, services and content and graciously ask for your feedback to help us be better.

Cheers to good health and happy juicing!

Your friends at Nama

Check us out online at www.namawell.com





04

Notes





05 IMPORTANT SAFEGUARDS

1. WHEN USING ELECTRICAL APPLIANCES, BASIC SAFETY PRECAUTIONS SHOULD ALWAYS BE FOLLOWED. READ ALL INSTRUCTIONS.
2. TO PROTECT AGAINST RISK OF ELECTRICAL SHOCK, DO NOT PUT THE MAIN BODY (MOTOR) IN WATER OR ANY OTHER LIQUID.
3. THIS APPLIANCE IS NOT INTENDED FOR USE BY CHILDREN OR BY PERSONS WITH REDUCED PHYSICAL, SENSORY, OR MENTAL CAPABILITIES, OR LACK OF EXPERIENCE AND KNOWLEDGE. CLOSE SUPERVISION IS NECESSARY WHEN ANY APPLIANCE IS USED NEAR CHILDREN. CHILDREN SHOULD BE SUPERVISED TO ENSURE THAT THEY DO NOT PLAY WITH THE APPLIANCE.
4. TURN THE APPLIANCE OFF, THEN UNPLUG FROM OUTLET WHEN NOT IN USE, BEFORE ASSEMBLING OR DISASSEMBLING PARTS AND BEFORE CLEANING. TO UNPLUG, GRASP THE PLUG AND PULL FROM THE OUTLET. NEVER PULL FROM THE POWER CORD.
5. AVOID CONTACT WITH MOVING PARTS.
6. DO NOT OPERATE ANY APPLIANCE WITH A DAMAGED CORD OR PLUG, OR AFTER THE APPLIANCE MALFUNCTIONS, OR IS DROPPED OR DAMAGED IN ANY MANNER. PLEASE CONTACT NAMA CUSTOMER CARE CENTER TO RETURN APPLIANCE.
7. THE USE OF ATTACHMENTS NOT RECOMMENDED OR SOLD BY THE MANUFACTURER MAY CAUSE FIRE, ELECTRIC SHOCK OR INJURY.
8. DO NOT LET CORD HANG OVER EDGE OF TABLE OR COUNTER.
9. ALWAYS MAKE SURE HOPPER IS SECURELY FASTENED IN PLACE BEFORE MOTOR IS TURNED ON. DO NOT UNFASTEN HOPPER WHILE JUICER IS IN OPERATION.
10. BE SURE TO TURN SWITCH TO OFF POSITION AFTER EACH USE OF YOUR JUICER. MAKE SURE THE MOTOR STOPS COMPLETELY BEFORE DISASSEMBLING.
11. DO NOT PUT YOUR FINGERS OR OTHER OBJECTS INTO THE JUICER WHILE IT IS IN OPERATION. IF FOOD BECOMES LODGED IN OPENING, USE FOOD PUSHER OR ANOTHER PIECE OF FRUIT OR VEGETABLE TO PUSH IT DOWN. WHEN THIS METHOD IS NOT POSSIBLE, TURN THE MOTOR OFF AND DISASSEMBLE JUICER TO REMOVE THE REMAINING FOOD.
12. DO NOT USE OUTDOORS.
13. DO NOT PLACE ON OR NEAR A HOT GAS OR ELECTRIC BURNER OR IN A HEATED OVEN.
14. DO NOT USE APPLIANCE FOR OTHER THAN INTENDED USE.

SAVE THESE INSTRUCTIONS



06 PRECAUTIONS FOR SAFE USE

- **DO NOT PLUG OR UNPLUG WITH WET HANDS.** It may cause electric shock or injury.
- **DO NOT USE OTHER THAN 230-240 V AC.** It may cause electric shock, fire or product failure. If the voltage is different, it may shorten the life of the motor or cause a failure.
- **PLUG THE POWER CORD IN CORRECTLY AND PUSH IT TIGHTLY INTO A WALL SOCKET.** It may cause an electric shock or a fire.
- **IF THE POWER CORD IS DAMAGED, IT MUST BE REPLACED BY THE MANUFACTURER'S SERVICE CENTER OR SIMILARLY QUALIFIED PERSONS, IN ORDER TO AVOID A HAZARD.** If the power cord is damaged, it may cause electric shock or fire.
- **NEVER ALTER THE APPLIANCE. ALSO, DO NOT DISASSEMBLE OR REPAIR THE PRODUCT BY YOURSELF. DO NOT INSERT FINGERS, FOREIGN SUBSTANCES OR OBJECTS SUCH AS PINS INTO GAPS OR HOLES IN THE BODY.** It may cause a fire, electric shock or product failure. For any technical support, contact the Customer Service.
- **WHEN THE POWER CORD OR WIRE IS DAMAGED OR THE PLUG-IN PART BECOMES LOOSE, DO NOT OPERATE IT.** It may cause electric shock, fire or injury.
- **DO NOT MOISTEN BODY OR SPLASH WATER ON THE BODY.** Be careful not to let any liquids or other substances get into the switch of the appliance.
- **DO NOT OPERATE THE SWITCH WITH WET HANDS.** It may cause an electric shock or fire.
- **FOR SAFETY, MUST DO GROUNDING CONNECTION. ALSO, DO NOT DO THE GROUNDING ON GAS PIPE, PLASTIC WATER PIPE, TELEPHONE WIRE, ETC.** It could cause electric shock, fire, malfunction or explosion. Be sure to use the electrical outlet with ground connection.
- **NEVER DISASSEMBLE THE CHAMBER SET DURING OPERATION OR INSERT FINGERS, FOREIGN OBJECTS SUCH AS FORKS, SPOONS, ETC. INTO HOPPER CHUTE OR JUICE OUTLET.** It may cause injury, accident or product failure.
- **APPLIANCES CAN BE USED BY PERSONS WITH REDUCED PHYSICAL, SENSORY OR MENTAL CAPABILITIES OR LACK OF EXPERIENCE AND KNOWLEDGE IF THEY HAVE BEEN GIVEN SUPERVISION OR INSTRUCTION CONCERNING USE OF THE APPLIANCE IN A SAFE WAY AND IF THEY UNDERSTAND THE HAZARDS INVOLVED. CHILDREN SHALL NOT PLAY WITH THE APPLIANCE. CLEANING AND USER MAINTENANCE SHALL NOT BE MADE BY CHILDREN. THIS APPLIANCE SHALL NOT BE USED BY CHILDREN. KEEP THE APPLIANCE AND ITS CORD AWAY FROM CHILDREN.**
- **DO NOT OPERATE WITHOUT LOCKING THE HOPPER PROPERLY.** It may cause an injury or a failure.
- **WHEN A GAS LEAK IS DETECTED, DO NOT INSERT THE POWER CORD INTO ITS SLOT. OPEN THE WINDOW IMMEDIATELY FOR AIR VENTILATION.** It may cause injury or failure.
- **NEVER PUT FINGERS, FORKS OR ANY OBJECTS INTO JUICE OUTLET.** It may cause injury or failure.
- **IF ROTATION OF AUGER IS STOPPED DURING NORMAL OPERATION, PRESS [REV] BUTTON AND HOLD FOR 2-3 SECONDS AND AFTER REVERSE OPERATION IS COMPLETELY STOPPED, PRESS [ON] BUTTON AGAIN.** If such stop continues during the operation, the parts may be damaged and performance may be deteriorated due to overheating in a motor. When the problem continues, stop the appliance immediately and contact Customer Service.
- **DURING THE OPERATION, DO NOT ATTEMPT TO MOVE THE BODY, DISASSEMBLE THE CHAMBER SET OR PARTS AND TRY TO LOCK THEM.** It may cause an injury or a failure. If needed, switch off first and unplug the power cord.
- **WHEN USING THE APPLIANCE, BE CAREFUL WITH A NECKTIE, LONG NECKLACE, SCARF, ETC. TO NOT BE BE ENTANGLED INTO HOPPER CHUTE.** It may cause injury, failure or breakage.
- **PLACE THE APPLIANCE ON A FLAT AND STABLE SURFACE.** It may cause injury or failure.
- **WHEN PLACING INGREDIENTS INTO THE HOPPER CHUTE, USE ONLY THE PUSHER PROVIDED.** It may cause injury or failure.
- **DO NOT ALLOW A SEVERE SHOCK TO THE APPLIANCE OR DROP IT.** It may cause electric shock, fire or damage.
- **IF THE APPLIANCE GIVES OFF AN UNPLEASANT SMELL, EXCESSIVE HEATING, OR SMOKE, STOP USING IMMEDIATELY AND CONTACT CUSTOMER SERVICE.** When using a new appliance, it gives off a smell and the smell disappears naturally over time.
- **ALWAYS UNPLUG THE APPLIANCE AFTER USE. ALWAYS DISCONNECT THE APPLIANCE FROM THE SUPPLY IF IT IS LEFT UNATTENDED AND BEFORE ASSEMBLING, DISASSEMBLING OR CLEANING. WHEN UNPLUGGING THE POWER CORD, MAKE SURE TO HOLD THE POWER CORD.** Pulling the wire to unplug may cause electric shock or fire.
- **DO NOT WASH AT HIGH TEMPERATURES OF 80°C (176°F) OR HIGHER. DO NOT PUT THE APPLIANCE IN A DISHWASHER, DRYER OR A MICROWAVE, ETC.** It may cause a failure or parts deformation.
- **THE APPLIANCE WEIGHS ABOUT 6.5 kg (14.3 lb). WHEN MOVING THE APPLIANCE, ENSURE TO MOVE IT HOLDING GRIPS TIGHTLY AT THE BOTTOM OF BODY WITH BOTH HANDS.** By attempting to hold chamber or the edge of the body, the body may fall causing an injury or failure.
- **DO NOT USE THE APPLIANCE IF THE ROTATING SIEVE OR THE PROTECTING COVER IS DAMAGED OR HAS VISIBLE CRACKS.**
- **THIS APPLIANCE IS INTENDED TO BE USED IN HOUSEHOLD AND SIMILAR APPLICATIONS SUCH AS:**
 - Staff kitchen areas in shops, offices and other working environments;
 - Farm houses;
 - By clients in hotels, motels and other residential type environments;
 - Bed and breakfast type environments.

07 CAUTIONS DURING OPERATION

*** Please use caution with the following ingredients, which may cause damage or failure to product.**

- Hard seeds and pits must be removed before juicing. Examples of fruits with hard seeds and pits include peaches, nectarines, mangoes, apricots, cherries, plums, etc.

- For stalk vegetables with strong fiber such as water parsleys, celery etc. should be cut into small size about 1-2 pieces before putting into the hopper chute.

- Do not put in sesame, coffee beans, Chinese pepper, etc. which cannot be extracted.

- Do not put in fruits preserved in alcohol, sugar, honey, etc. (grapes, apricot, berries, etc.) and enzymes (glasswort, house leek, etc.).

*** We recommend you to drink green vegetable juice and fruit juice immediately after extraction rather than keeping them for long time.**

*** Do not use for grinding grains.**

- It may cause damage or failure.

*** Do not re-squeeze residues expelled through the pulp outlet.**

- Soft fruits can be re-squeezed.

*** Do not operate the appliance before putting in the ingredients.**

*** Do not use the appliance for more than 30 minutes continuously.**

- It may cause a failure due to overheating of the motor.

- When using continuously, every 30 minutes, stop for 5 minutes to allow motor to cool down and then resume operation.

*** Never insert finger, fork or spoon etc. into juice outlet, pulp outlet, or hopper chute during the operation.**

- Inserting such objects into juice outlet, pulp outlet or hopper chute during operation may cause damage and breakage to the product and can result in harm or injury.

*** Do not press the ingredients with anything except the pusher.**

- It may cause damage or failure of product and injury to persons.

*** Do not operate the switch with wet hands.**

- It may cause electric shock or fire. Do not put foreign objects near the switch.

*** When you extract over 400ml at once, please open the pulp control lever every 400ml to emit the pulp.**

- The hopper may be difficult to open or it may cause damage to product when the pressure inside the chamber increases.

*** Please only use sorbet strainer for frozen fruits.**

Do not insert ice cubes or other ingredients for grinding.

- It may cause damage or failure.

NOTE

If the unit is not cleaned immediately after use, a residue may dry and stick to the unit. This will make assembling and cleaning difficult as well as lead to performance degradation.

08

Parts and Accessories

01 Hopper x 1

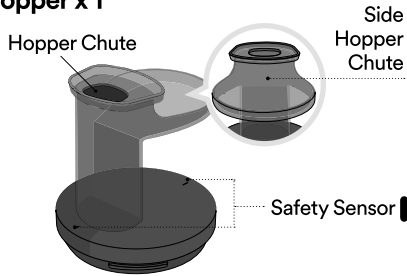

02 Spinning Brush x 1

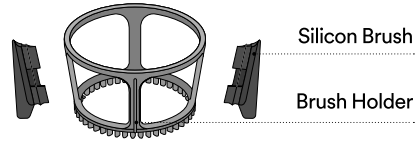

03 Auger x 1

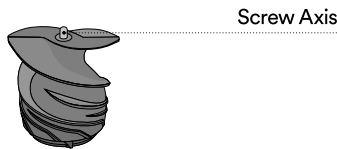

04 Chamber x 1

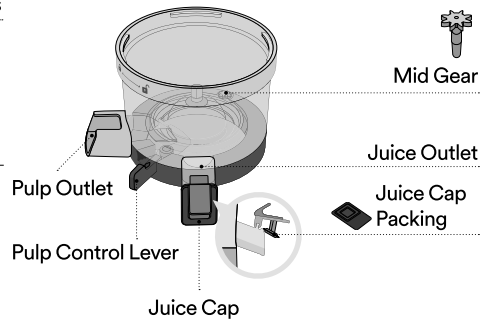

05 Pusher x 1

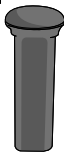

06~08 Strainer

06 Juice Strainer x 1

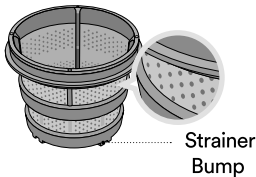

07 Smoothie Strainer x 1

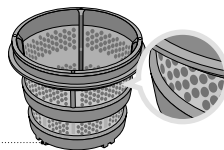

08 Sorbet Strainer x 1

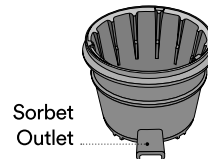

09 Juice Container Cover x 1



10 Juice Container x 1



11 Pulp Container x 1

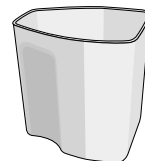

09

Parts and Accessories

12 Base x 1

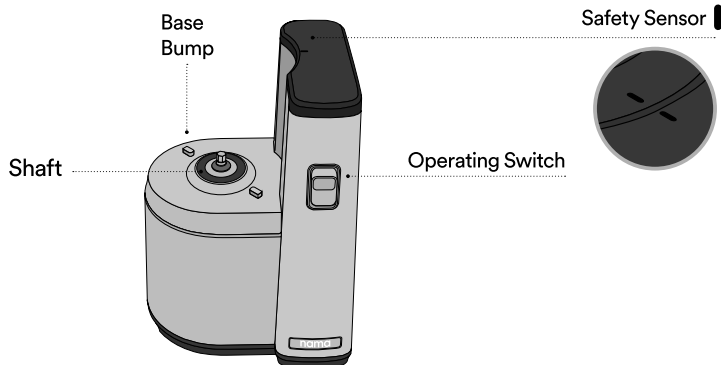

13 Cleaning Brush x 1

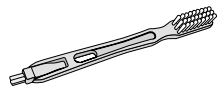

10

How to Disassemble: Chamber

* Please clean all the parts before first use.

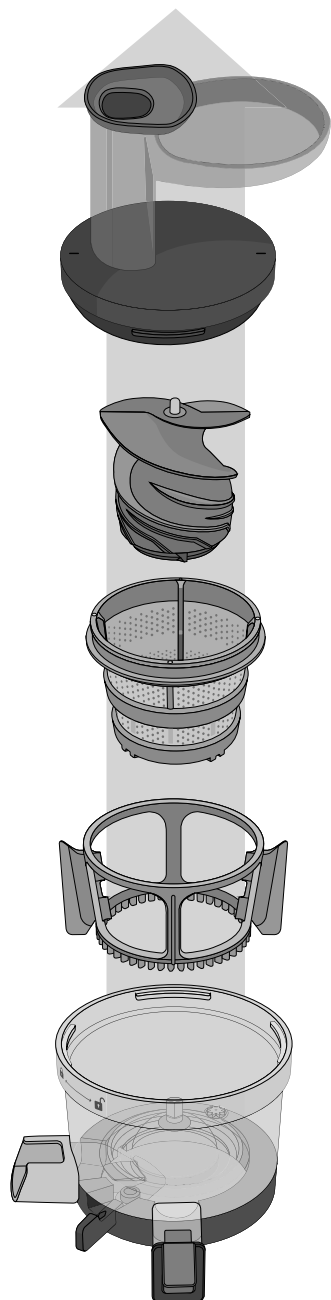

- 1** Turn the hopper counterclockwise, so the safety line on top of lid moves from lock symbol to unlock symbol on outside of chamber, then pull up to remove.



NOTE

If hopper lid is stuck or difficult to remove:

Place chamber set on base, press [REV] button for about 10 seconds, allow to stop. Keeping chamber set on base, turn hopper counterclockwise using the chamber and base for leverage.

- 2** Disassemble the auger, strainer and spinning brush from the chamber.

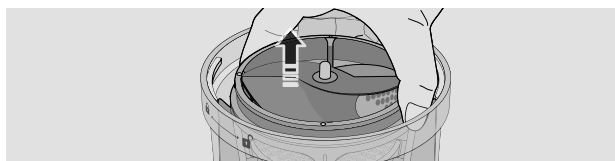

- 3** Pull out the auger holding both sides of wing.

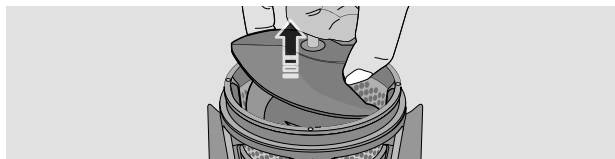

- 4** Disassemble the spinning brush and strainer.



11

How to Assemble: Chamber Set and Base

* The assembly method is the same regardless of strainer type.

- 1** The chamber can only be assembled to the base with the pulp control lever in the **●** CLOSE position.

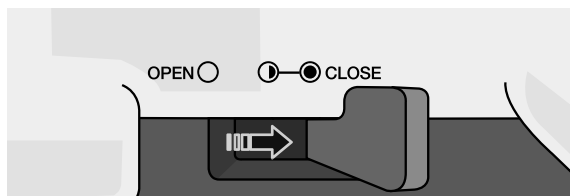

- 2** Fit the bottom of the chamber to the base bump.
If the pulp control lever is not placed on **●** CLOSE, the chamber set and base will not fit completely.

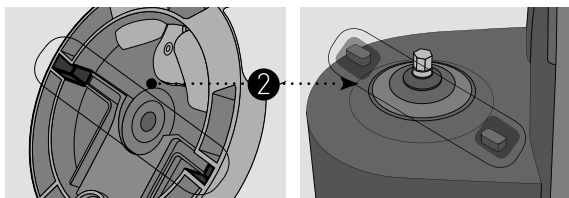

- 3** If the sign **<|>** on the top of base and the sign **<|>** on the chamber set are aligned well, it is perfectly assembled.

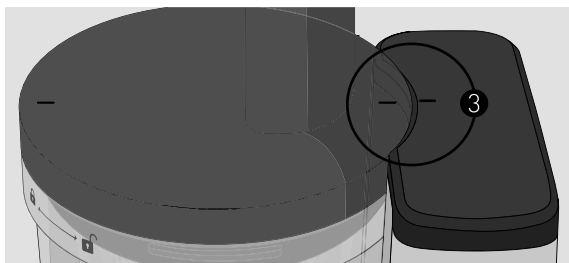

NOTE

The main base will not work by itself, the chamber set must be on base with safety sensors aligned in order to operate.

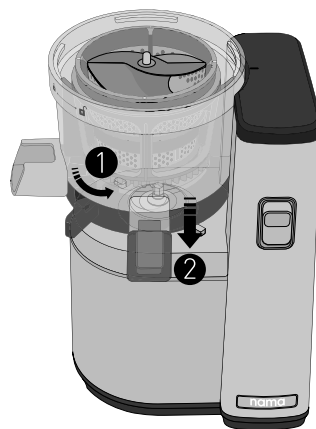

12

How to Assemble: Juice & Smoothie Strainer

1
STEP

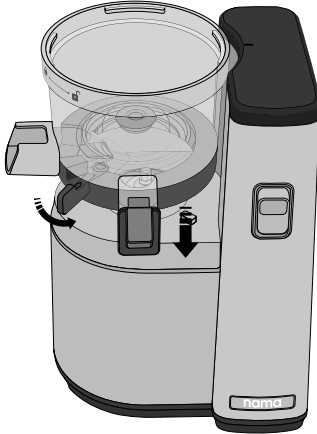

Place the pulp control lever in **●** CLOSE position and then place the empty chamber onto base.

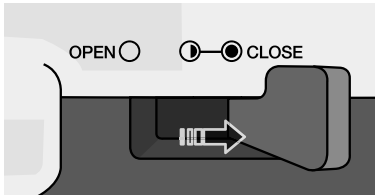

If the pulp control lever is not placed on **●** CLOSE, the chamber set and base will not fit completely.

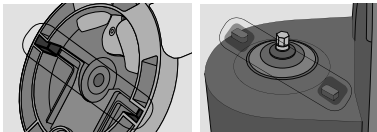

Fit the bottom of the chamber to the base bump.

2
STEP

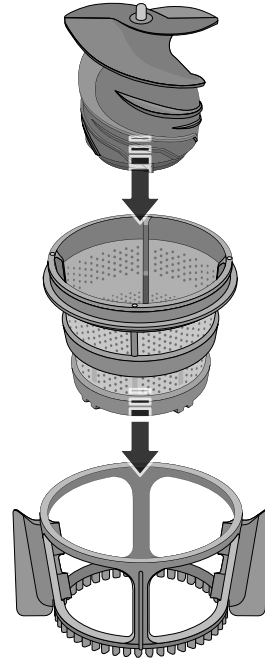

Place the auger into the strainer, then into the spinning brush.

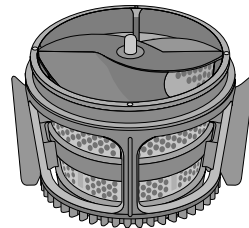

13

How to Assemble: Juice & Smoothie Strainer

3
STEP

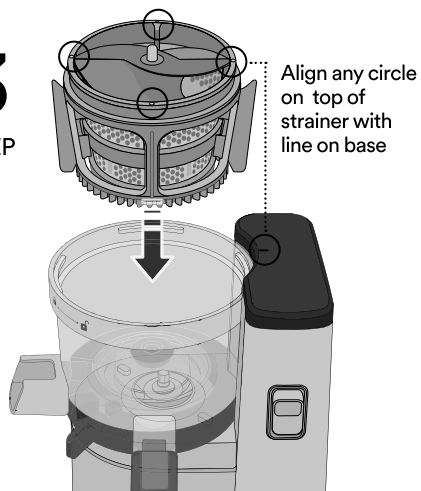

Place the assembled parts from [STEP 2] into the chamber by aligning any circle on top of the strainer to the safety line on top of back of base to fit the groove in the bottom bump of the chamber.

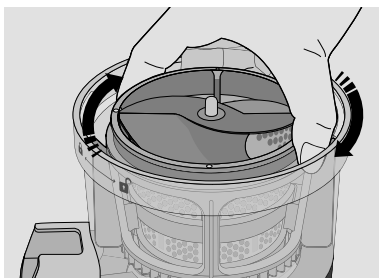

4
STEP



Assemble the hopper, like the picture, with either safety line aligned with unlock symbol on chamber and turn it clockwise until it is locked completely and the safety line is aligned with lock symbol.

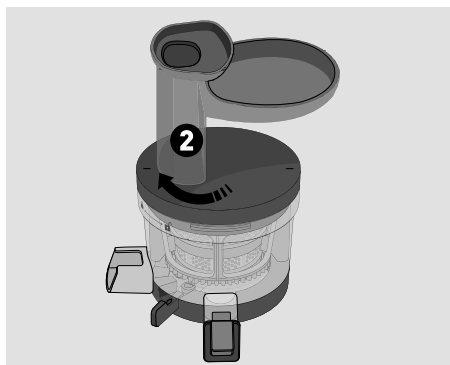

NOTE

The hopper can be operated when assembled in either direction for easier operation by user.

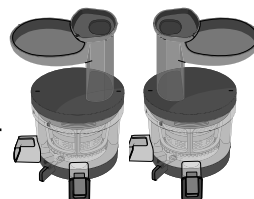

14

How to Assemble: Sorbet Strainer

1
STEP

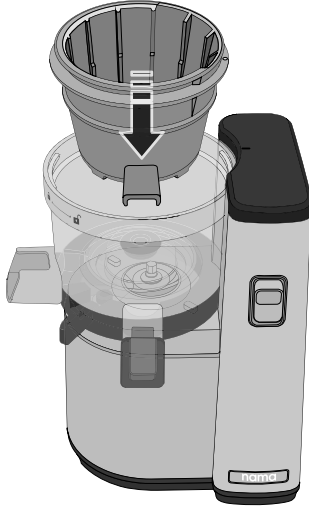

2
STEP

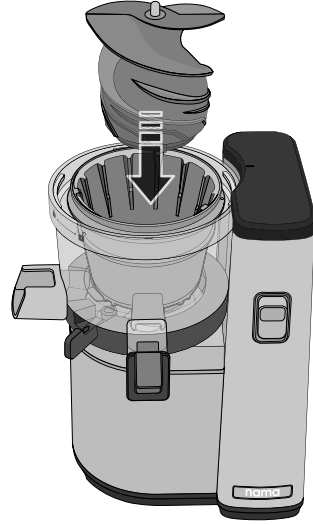

Assemble the chamber and sorbet strainer. Place the sorbet strainer with outlet spout aligned with juice outlet in the chamber.

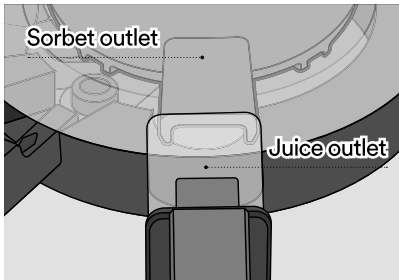

Press the auger into the assembled parts from [STEP 1] until the screw fits perfectly.

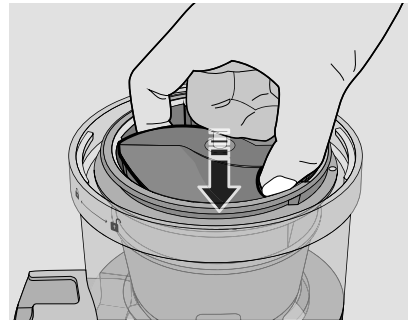

NOTE

The spinning brush isn't needed for making sorbet.

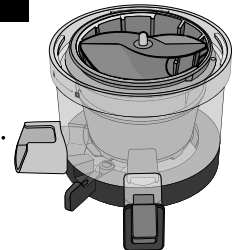
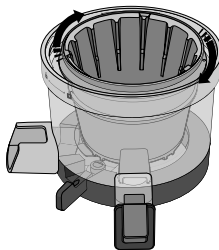

15

How to Assemble: Sorbet Strainer

3

STEP

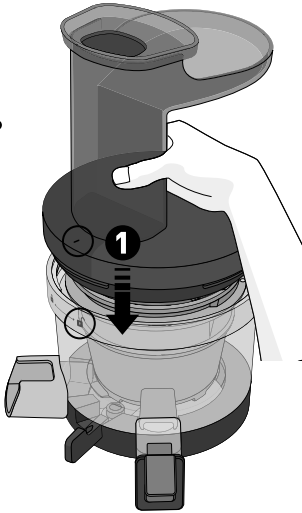

Assemble the hopper, like the picture, with either safety line aligned with unlock symbol on chamber and turn it clockwise until it is locked completely and the safety line is aligned with lock symbol.

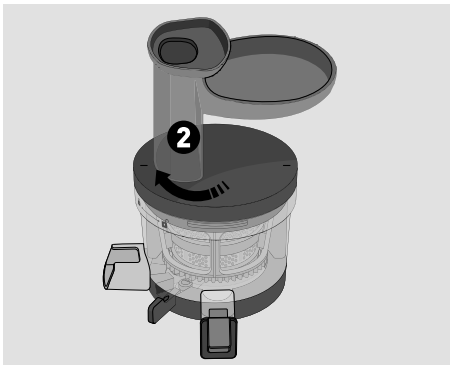

NOTE

The hopper can be operated when assembled in either direction for easier operation by user.

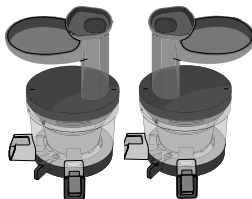

How to Prepare the Ingredients for Optimal Juicing

How to trim the ingredients for optimal juicing

Apple, pear, kiwi	Fruits like apple, pear, kiwi, etc. put them with seeds and peels. However, apple seeds contain toxicity, so it is better to remove them.
Pomegranate, grapes	Separate each grape from the cluster. Peel the pomegranate and use flesh only.
Watermelon, melon, orange, grapefruit, lemon	Peel off the skin of watermelon, melon, orange, grapefruit, lemon and cut them into appropriate size to fit in chute.
Mango, cherry, peach, lemon	Fruits like mango, cherry, peach, lemon or plum, etc. have hard seeds. Those seeds might cause stoppage or parts damage, so they must be removed before using it.
Wheat, chives, Water parsleys, celery, kale	Cut fibrous ingredients into appropriate sized pieces to fit in chute. Put a handful of wheat or chives in not to be scattered.
Ginger · Garlic	When juicing fibrous ingredients, including ginger, cut to appropriate size to fit in chute and insert slowly. When extracting juice from root vegetables, including ginger (carrot, dandelion, potato, beet, etc.), non-food materials such as dirt on the surface may damage the parts. Please remove peels before using the product. When extracting a large amount of juice, repeat the process of "disassembling and cleaning after extracting juice from 2.25 lbs of ingredients".



How to trim the ingredients for making sorbet

Flesh	Dice frozen fruits as 3/4 inch to make sorbet. When using fruits with shells or hard skin, please peel and freeze to use. Hard seeds in fruits, such as mangoes, cherry, nectarine, lemon, plum, peach etc., that are hard to chew with our teeth should be taken out before freezing. Please use seedless grapes.
--------------	--

* This is a reference about how to trim the ingredients, so if you have allergy please choose your own proper ingredients.

* Please refer to the recipe book for the product usage of each ingredient.

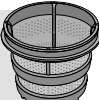
USE BY STRAINER TYPES

Smoothie strainer		Smoothie strainer has larger holes for making thick and pulpy juice. Great if you like pulp and fiber. Also used to make smoothie, latte and soups.
Juice strainer		Juice strainer has small fine holes for making pulp-free juice. Great for making silky smooth nut milks.
Sorbet strainer		Sorbet strainer is used for making sorbet, ice cream and frozen desserts. The sorbet may leak out of the pulp outlet or outside of the strainer, which is normal and not a product failure. Do not use ice cubes or frozen liquids.

NOTE

The sorbet strainer is only for frozen fruits.
Do not use for crushing ice and grinding.

17

How to Use: Overview

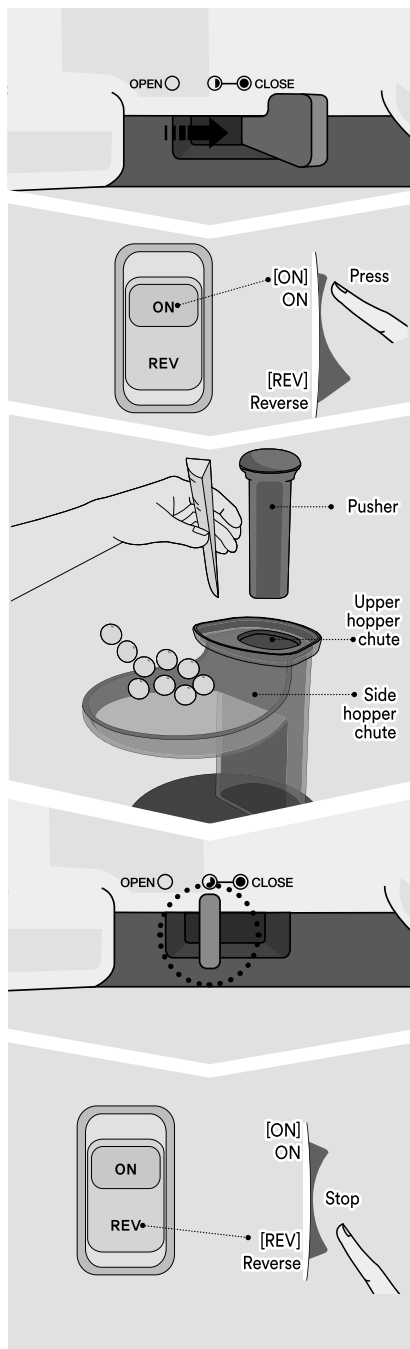

- 1 Place the pulp control lever into CLOSE (● CLOSE) position before operating.

- 2 Press [ON] button to start.
For your safety, this appliance only works when it's correctly assembled with chamber set.

- 3 Put ingredients gradually in the hopper chute and press with the pusher.

Do not press the ingredients with anything except the pusher provided. Ingredients need to be appropriate size to fit in the hopper chute.

When you extract over 13.5 oz (400 ml) at once, please open the pulp control lever every 13.5 oz (400 ml) to help release the pulp from strainer.

- 4 Juice: Place the pulp control lever in half-open (◐) when putting the last ingredients.
Sorbet: Only use with pulp control lever in close (● CLOSE) position.

When using juice or smoothie strainer, after extracting 13.5 oz (400 ml), toggling the pulp control lever between half-open and close position a few times will help release the pulp residues and make it easier to open the hopper.

- 5 After extraction is completed, press the reverse [REV] switch position.

For safety, allow the machine to come to a complete stop. Press [REV] button for about 10 seconds to loosen up pulp and allow for easier disassembly.

NOTE

When using [ON] or [REV] button, make sure that the auger is completely stopped before pressing either button.

18

How to Use: Pulp Control Lever by Mode

* The pulp control lever is between the juice cap and pulp outlet.

[● CLOSE] Preparation/Extraction mode

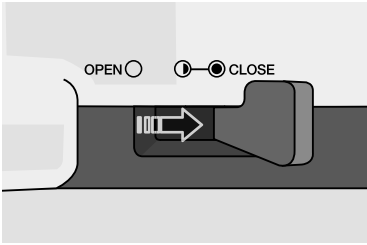

Always start operation with the pulp control lever in close position. When you are extracting more than 13.5 oz (400 ml) at one time, please toggle lever between half-open and close position and leave in half-open position to help release the pulp residues.

[● CLOSE] Sorbet mode

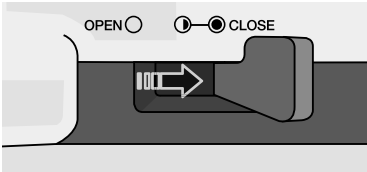

Close (● CLOSE) the pulp control lever to use since the pulp is not released separately.

[⦿] Completion, Simple Cleaning Mode

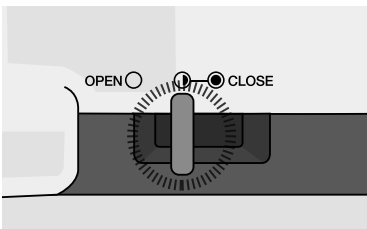

For easier cleaning, and to open the hopper more easily, release the pulp residues by toggling the lever between the half-open and close position and leave in half-open position when you are putting in last ingredients for extraction.

For Simple Cleaning Mode, place the pulp control lever into half-closed (⦿) position and release the residues.

[○ OPEN] Cleaning Mode

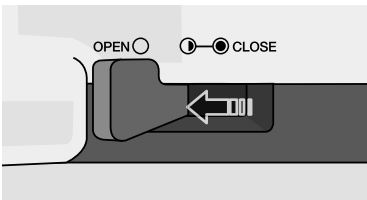

When detaching and cleaning the chamber, place the pulp control lever completely into (○ OPEN) position. You can easily and conveniently clean the chamber.

NOTE

When it is hard to open the hopper after the operation: Place the pulp control lever into half-closed (⦿) position and press Reverse button for about 3~4 seconds. Repeat this for 2~3 times and the hopper will be open easily.

19

When Auger Stops During Operation

*The appliance may stop if ingredients are overloaded or inserted quickly.

*Gradually insert ingredients, since the product squeezes them instead of grinding.

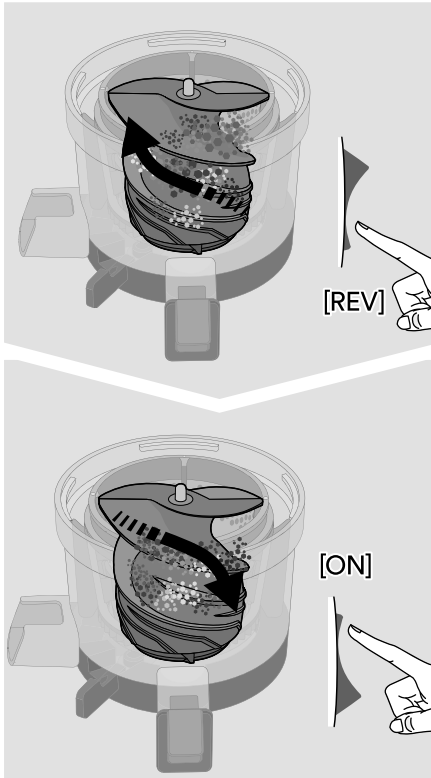

- 1 Press **[REV]** button on the operating switch for about 3~5 seconds and stop it. Repeat this 2~3 times.

[REV] is the button to push back the ingredients upward.

[REV] only works while pressing the button, and the rotation of the auger stops if you release the button.

- 2 Press **[ON]** button to operate after reverse operation is completely stopped.

When using [ON] or [REV] button, make sure that the auger stops completely.

NOTE

Even after following the directions above and still doesn't work, please unplug the power cord and disassemble chamber set, and clean it. Then, try it again.

Caution when using operation button

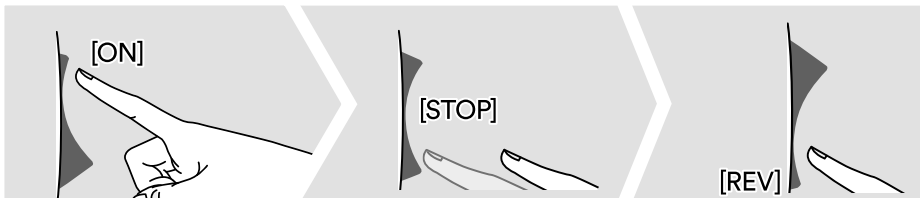

NOTE

In case of reversing during operation, press **[REV]** button shortly to stop the appliance, then you press **[REV]** button for operation.

From the feature of the product, even though you stop the operation, it doesn't stop right away. It rotates slowly then stops. If the rotation stops completely, you may press the button to any direction you want.

How to Clean

Clean the parts

- 01 After you have finished juicing, to help make cleanup a little easier, with the juice cap closed and an empty juice container placed under juice outlet, add about 16 oz of warm soapy water to the hopper tray filling up juice chamber. Make sure the pulp control lever is in closed position. Turn on juicer and run for 1-2 minutes, open juice cap and allow chamber to empty and continue to next steps for cleaning.
- 02 Unplug the power cord with dry hands after the unit has been completely stopped.
- 03 Remove the chamber set from the main body. Twist the hopper to open and lift up the parts in order to disassemble the unit.
- 04 Use a cleaning brush and wash the chamber set under running water.
- 05 Open the pulp control lever (OPEN ○) and juice cap to wash the chamber
- 06 Wipe the main base with a damp towel or a soft cloth.
- 07 The silicone packing can be disassembled and washed. (Including juice cap packing, silicone brush)
- 08 You can sterilize and clean the product by soaking in water diluted with about 3.5 oz (100 g) baking soda and/or 3.5 oz (100 g) citric acid for about 30 minutes. Rinse and dry thoroughly.

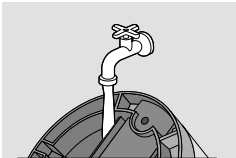

When you clean the chamber set, wash the residue inside and bottom of the chamber under running water.

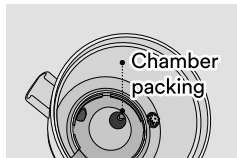

The chamber packing can't be disassembled. Do not disassemble the chamber packing. If you try to disassemble the chamber packing, it might get damaged.

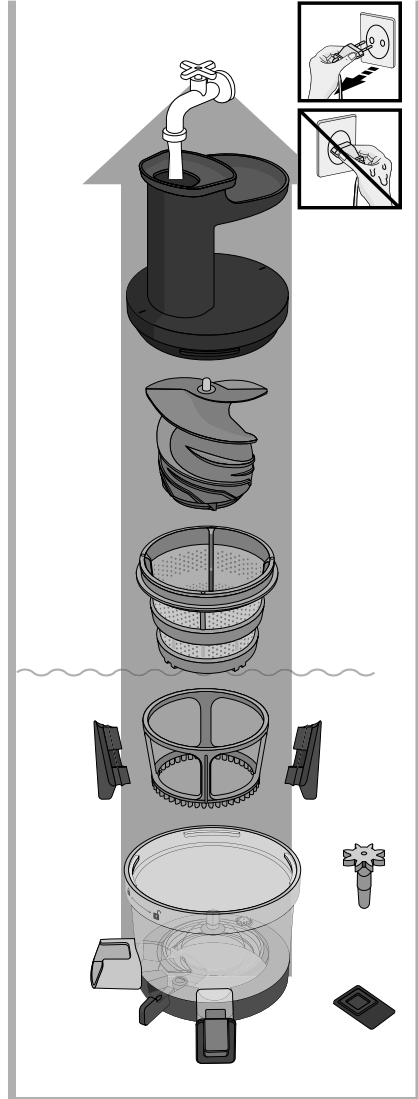

NOTE

1. If the chamber is not cleaned immediately after use, a residue may dry and stick to the unit. This will make disassembling and cleaning difficult as well as lead to performance degradation. Please wash the chamber set immediately after use.
2. Do not wash with hot or boiling water, an iron scrubber, abrasive material, sink solvents, or sharp cleaning tools. Do not put it in a dishwasher or dish dryer. After washing thoroughly, dry and store in a clean area.

21

How to Clean: Silicone Parts

Juice Cap Packing

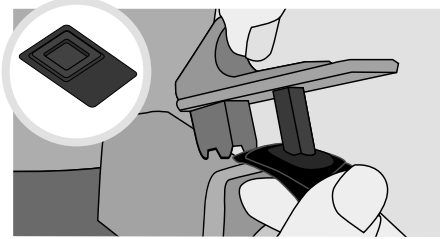

Open the juice cap, hold the chamber and juice cap with one hand, and remove the juice cap packing with your other hand to disassemble.

Please be careful not to drop or damage the juice cap and chamber when disassembling the unit.

Mid gear

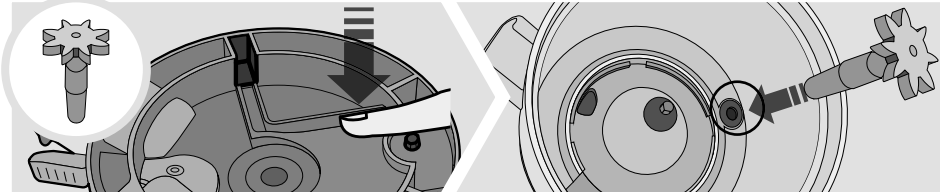

Push the mid gear from the bottom side of the chamber and then pull the gear out from the other side.

Replace the mid gear after cleaning by pressing down firmly into place.

Spinning Brush

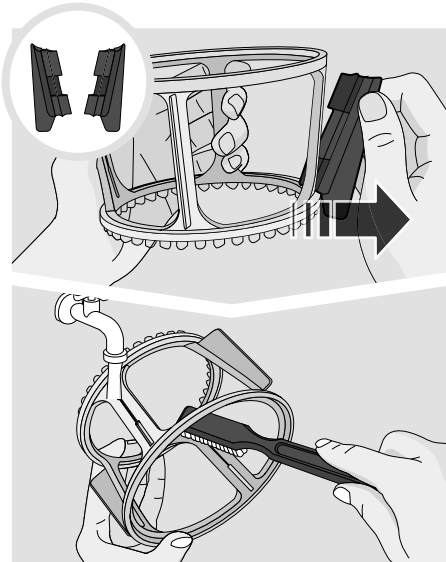

1 Remove the silicone brush from the spinning brush holder.

Please follow the recommended method to separate the silicone brush. Otherwise, it may cause damage to spinning brush holder and silicone brush.

2 Use a cleaning brush and wash the inside and outside of the spinning brush holder under running water.

Wash the silicone brush under running water using the same method.

Before Requesting for Repair / Troubleshooting



1. The main base itself will not work.

For your safety, this unit only works when it's correctly assembled with the chamber set.

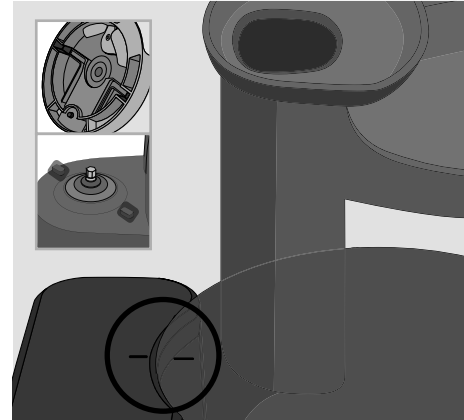

2. Please assemble according to the safety sensor.

For your safety, this unit only works when it's correctly assembled.

3. The appliance does not work.

Make sure that the power cord is properly plugged in.

The hopper lid does not close or lock properly.

If the hopper has not been locked into place, the appliance will not operate for safety reasons. Check if the auger, strainer, and spinning brush are assembled properly and perfectly fit into the chamber with the strainer assembly dot aligned with safety line on base. The safety lines on hopper lid must be aligned with lock symbol on chamber and safety line on base. Refer to instructions for assembly in the manual or consult with Customer Service for additional assistance.

4. The hopper does not open.

There might be a lot of residues inside. Put the pulp control lever in half-closed (ⓐ) position, and press [ON] button to release residues. Press [REV] button for 3~5 seconds and stop.

Repeat this process 2~3 times. With chamber set on base, turn hopper counterclockwise using the chamber and base as leverage to help remove hopper. Try adding 12-16 oz. water to help loosen up residue inside and repeat the above process.

Have you placed any foreign substances or solid objects (hard seed such as persimmon seed) in the juicer?

Press [REV] button and push the ingredients back up toward the hopper chute. If you are still unable to open hopper, please contact Customer Service for assistance.

5. Chamber set does not fit on to the base.

If the pulp control lever is in OPEN (ⓐ) position, the chamber set will not fit on the base. Before assembling the chamber set, make sure that the pulp control lever is in (ⓑ) CLOSE position.

23

If you need additional information, please visit www.namawell.com or contact Customer Service. When applying for after-sales service, please have the manufacturer's serial number or bar code available.



6. Do not insert too many ingredients at once.

If you insert an excessive amount of ingredients or thick ingredients, the unit may stop.

7. Do not use in ways other than pressing on the pusher in the inlet.

It may cause damage, injury, etc.

8. The appliance stops during normal operation.

Have you inserted heavy loads or large pieces of ingredients into the appliance?

Refer to page 15 of the manual and follow the guideline for using [REV] button. If the issue is not resolved after following the above process, please contact Customer Service.

9. Juice leaks over the base.

Have you inserted a lot of ingredients into the hopper chute?

If you insert a large amount of ingredients compared to the pulp outlet, the packing is slightly pushed away, so the juice leaks out of the gap. Do not put too much ingredients by force and just put gradually for extraction.

10. There are fine lines or scratch marks around the auger.

These are molding marks resulting from the normal manufacturing process. This is normal and there is no problem for use.

11. The chamber shakes when squeezing.

Slight shaking may be caused by the motor.

Depending on the texture of the ingredient, there may be slight shaking. This is a normal phenomenon as auger rotates and it is not a malfunction. Hard ingredients (e.g. carrot, potato, radish, beet, etc.) may cause more shaking than soft ingredients.

Product Specifications

Product Name	Cold Press Juicer	Cord Length	1.4 m
Model Name	Vitality 5800	Motor	Single-phase induction motor
Model Number	SJ122-V	RPM	43 rpm
Rated Voltage	230-240 V	Fuse	250 V 5 A
Rated Frequency	50 Hz	Weight (Chamber set included)	14.3 lbs (6.5 kg)
Rated Power Consumption	150 W <small>Energy efficiency is low at high rated power consumption(W).</small>	Outward Dimension	Width 8 in (203 mm) Length 9.5 in (241 mm) Height 17 in (431 mm)
Rated Operating Hour	Less than 30 minutes		

Warranty

Product name	Customer Name	Model Name
Supplier	Date of Purchase	
Address	Serial Number	

1. Important: To better protect your purchase, fill out this form for your records and register your product online. Be sure to keep the original receipt.

2. This certifies that the Nama Cold Press Juicer is covered under warranty by Nama to be free from defects in material construction and workmanship.

Nama provides warranty for ten (10) years for the motor and two (2) years for other parts from the date of purchase by the original purchaser. Coverage is valid only with proof of purchase from an Authorized Local Distributor.

This warranty does not apply to damages caused by accident, misuse, abuse, commercial use, alteration, failure to follow operating instructions, or damage caused by parts or service unauthorized by Nama. Damages caused by transportation must be claimed with carrier. Nama disclaims all responsibilities for consequential damages from incidental losses caused by use of this appliance.

3. Please check the bottom of your Nama product for a sticker with a barcode. This barcode sticker helps verify a genuine Nama product and identify the product manufacturing date. Nama's manufacturer's warranty does not cover products with missing or damaged barcode stickers. Products are to be inspected upon receipt.

4. For service and assistance with technical difficulty, please contact our local customer care center.

Nama Customer Care
Toll Free: 833-253-NAMA (6262)
support@namawell.com
© 2020 Nama, All rights reserved.

ML-SJ122-VA_V1

nama[®]
www.namawell.com